

OPERATING INSTRUCTIONS & SERVICE MANUAL

AM/FM STEREO TUNER

SANSUI TU-7500



Sansui

SANSUI ELECTRIC CO., LTD.

We are grateful for your choice of the TU-7500 FM/AM Stereo Tuner.

For over a quarter of a century, Sansui has been building hi-fi audio equipment, and nothing else. Our mission is very old and at once ever new to us: to bring the reproduced sound closer to the original.

The TU-7500 now in your hands is one answer from us to this never-ending quest. It is a product of the cream of sophisticated modern audio-electronics knowhow, coupled with our long experience, and as such, we present it to you with our full confidence.

The TU-7500 is a matching tuner for the Sansui AU-7500 Integrated Amplifier. It features an FM multiplex circuit utilizing a differential amplifier for outstanding channel separation, distortion and phase characteristics, the last one being of particular importance in receiving discrete 4-channel FM broadcasts anticipated in the future.

This manual has been prepared to guide you in operating and caring for the tuner correctly, so that you will get the most out of its built-in high performance.

May we suggest that you read it once carefully?

CONTENTS

SWITCHES AND CONTROLS	3, 4
CONNECTIONS	5, 6
OPERATION	7
SIMPLE MAINTENANCE HINTS	7, 8
GENERAL TROUBLESHOOTING CHART	9
SPECIFICATIONS/ACCESSORIES	10
DISASSEMBLY PROCEDURE	11
TEST POINTS	12
SCHEMATIC DIAGRAM	13, 14
ALIGNMENT	15, 16
PRINTED CIRCUIT BOARDS AND PARTS LIST	17~24
OTHER PARTS AND THEIR LOCATION ON CHASSIS...	25, 26

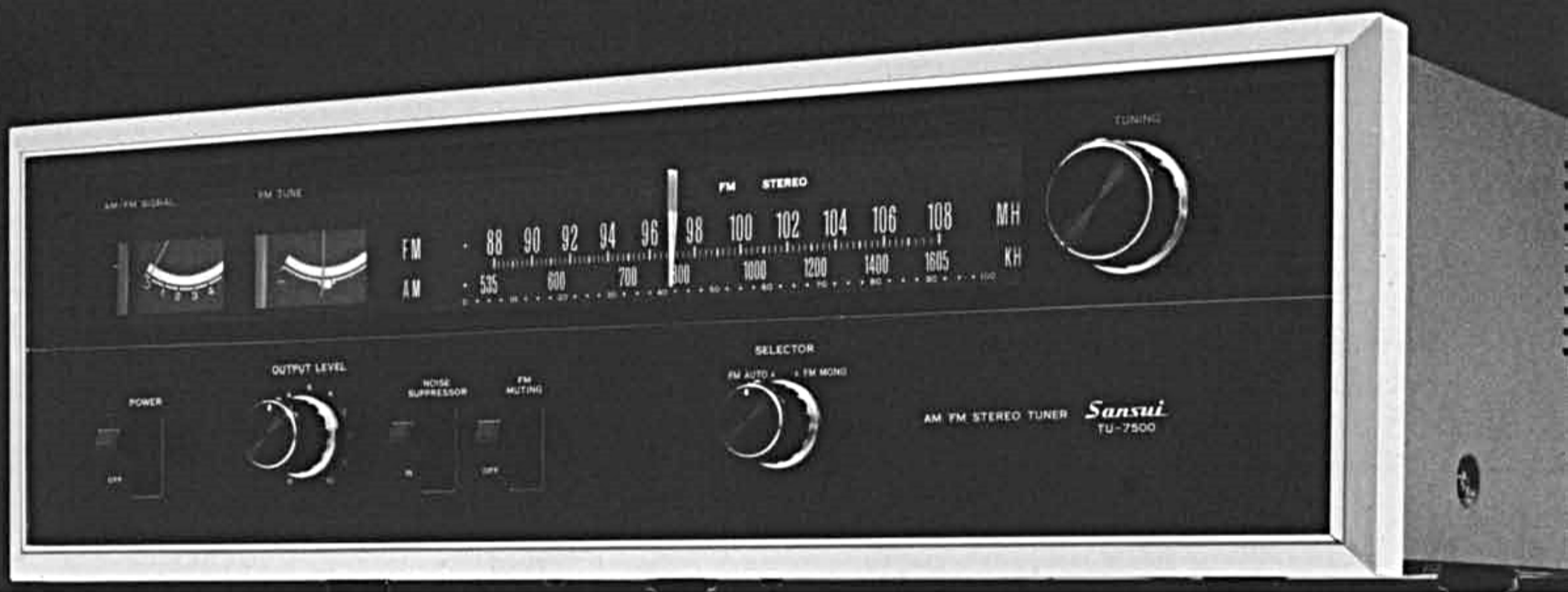

SWITCHES AND CONTROLS

Signal and Tuning Meters

Tune in the desired station while watching these meters.

If you are tuning in an FM station:

Adjust the Tuning Control first for maximum deflection of the Signal Meter on the left. Then adjust it so that the Tuning Meter on the right will indicate the exact center. The tuner will pinpoint the station and receive it with the best tone quality.

If you are tuning in an AM station:

Simply adjust the Tuning Control for maximum deflection of the Signal Meter. Ignore the Tuning Meter when tuning on AM.

AM Indicator

Lights when the Selector Control is set to AM.

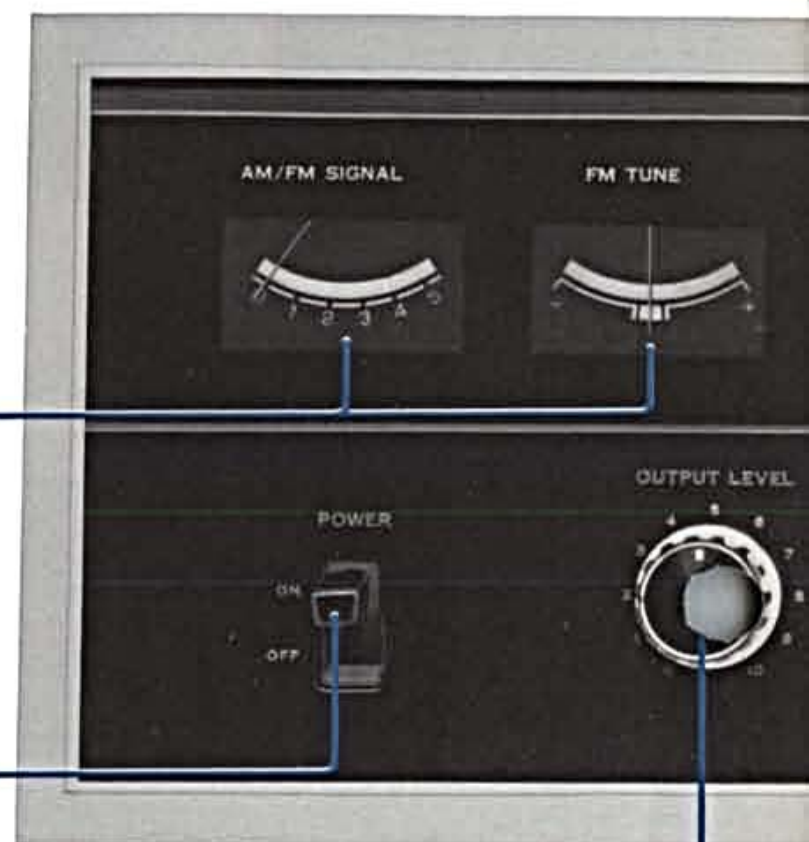

Power Switch

Pull up to ON to turn on the tuner.

Output Level Control

Adjusts the output signal level of the tuner. Turn clockwise to increase it. (Output at the TAPE REC terminals is constant and independent of this control.)

Noise Suppressor Switch

Push down to IN if loud noise is mixed with an FM stereo or AM broadcast. Noise will be suppressed and the broadcast will sound more pleasant to hear.

If you hear no noise, be sure to keep it at OUT.

FM Indicator

Lights when the Selector Control is turned to FM AUTO or FM MONO.

FM Stereo Indicator

Lights when the tuner is tuned in on an FM station broadcasting in stereo.

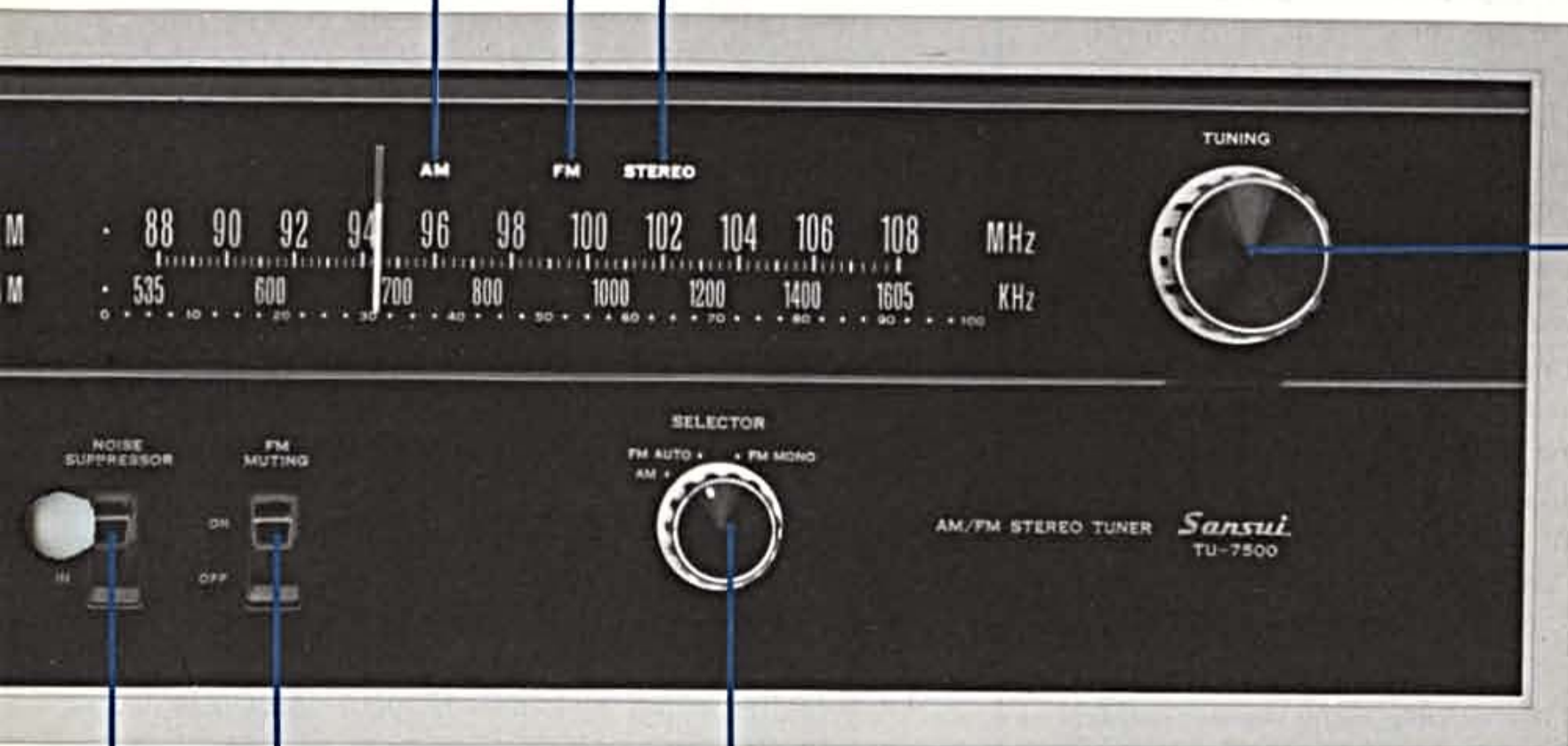

FM Muting Switch

When tuning on the FM band, noise is usually heard between stations which is peculiar to FM. Setting this switch to ON cuts off that noise and lets you tune quietly.

If you are trying to tune in a weak station, however, setting the switch to ON may cause the tuner to miss it. In that case, it is better to push the switch down to OFF and then tune.

Selector Control

AM: To receive AM broadcasts.

FM AUTO: To receive FM broadcasts, whether stereo or mono. When the broadcast signal changes from mono to stereo, the tuner will automatically switch itself to stereo reception.

FM MONO: If the FM stereo reception is too noisy for pleasant listening, set the control to this position. The broadcast will be received in mono but the noise will substantially decrease.

Tuning Control

Tune in the desired station by turning this control.

CONNECTIONS

Connecting Antennas

The quality of reception depends pretty much on the effectiveness of the antennas. Connect and install them correctly for noise-free pleasant reception.

FM Antennas

T-shaped Feeder Cable Antenna

If you live relatively close to FM stations, quality reception can be usually achieved by just installing the T-shaped feeder cable antenna supplied with the tuner. Connect it to the tuner's FM 300 Ω terminals, referring to the diagram at right. Stretch the antenna to a complete T shape, then prepare the tuner for FM reception. Adjust the height and direction of the antenna while actually listening to your favorite FM station.

Outdoor FM Antenna

In areas remote from broadcast stations or blocked by such obstacles as mountains and large buildings, the above-mentioned feeder cable antenna may fail to give you a quality reception of FM stations. In that case, install an outdoor FM antenna. Many different types of outdoor FM antenna are commercially available, but it is advisable to use one with at least 5 or 7 elements. Connect it to the tuner's FM 300 Ω terminals, using feeder cable. When making the connection, keep these points in mind:

1. Install the antenna as far away from streets as possible to prevent picking up automobile noise.
2. An antenna is directional. Adjust its direction for best reception while actually listening to your favorite FM station.
3. Keep the connecting feeder cable as short as possible.
4. Be careful not to let the antenna touch an electric cable, etc.

If you need long cable to connect the antenna or if automobile traffic is heavy around your house, it is better to use 75 Ω coaxial cable. Unless the antenna itself has an impedance of 75 Ω , you'll need an impedance matching transformer between the antenna and coaxial cable but the quality of FM reception will considerably improve. Connect the cable to the FM 75 Ω terminals of the tuner.

AM Antennas

AM Ferrite Bar Antenna

The sensitive AM ferrite bar antenna provided on the tuner's rear panel provides a clear AM reception in most areas. To use, simply pull it out as illustrated.

Outdoor AM Antenna

Should the bar antenna fail to give you clear reception, however, connect a piece of polyvinyl wire supplied to the AM-A terminal on the tuner's rear panel and stretch it outside a window or on the roof. Still better results would be obtained by grounding the tuner.

Connecting to an Amplifier

Connect the OUTPUT terminals of the tuner with the TUNER or AUX terminals of your amplifier (integrated amplifier or preamplifier), using the pair of pin plug cables supplied, as illustrated.

Be careful not to confuse the left and right channels.

Connecting to a Tape Deck

If you connect the tuner to a stereo tape deck, you can record directly from the tuner.

Connect the TAPE REC terminals of the tuner with the recording input terminals of your tape deck, also using pin plug cables.

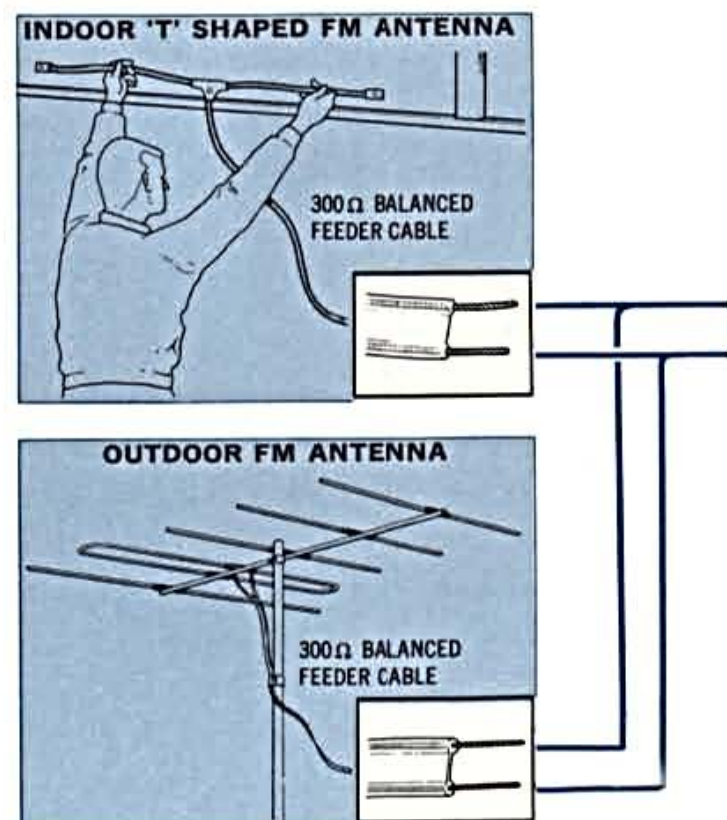

CONNECTING ANTENNA CABLE

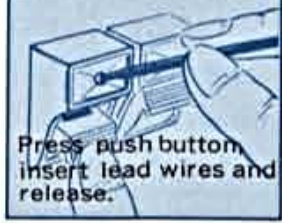

OUTDOOR AM ANTENNA

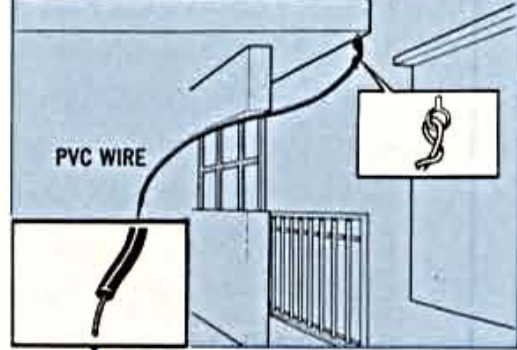

AM FERRITE BAR ANTENNA

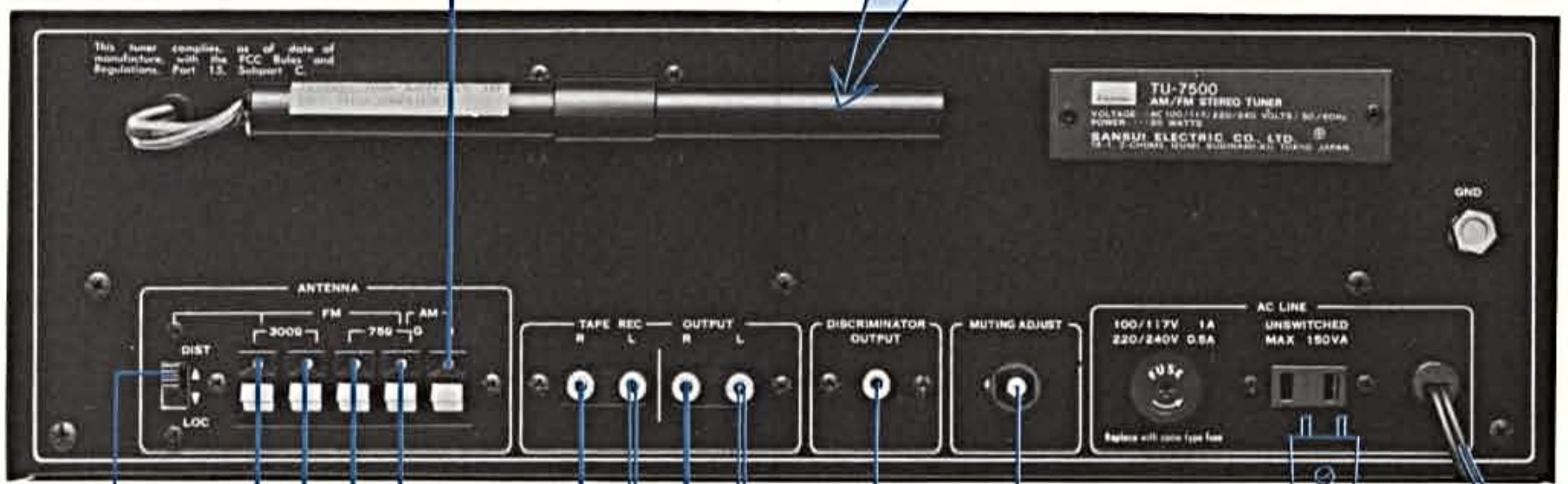

FM LOCAL/DISTANT SWITCH (SEE p. 7)

FM MUTING LEVEL CONTROL (SEE p. 7)

DISCRIMINATOR OUTPUT TERMINAL (SEE p. 8)

TO TAPEDECK, ETC.
CAUTION:
Never connect equipment with greater power requirements than specified maximum rating.

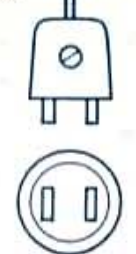

WALL AC OUTLET

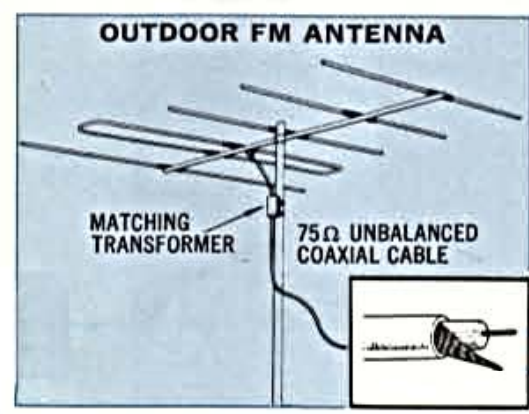

TAPE DECK

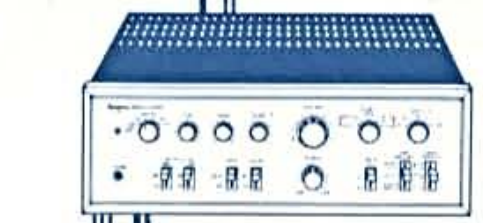

INTEGRATED AMPLIFIER

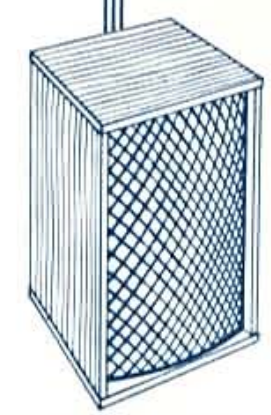

LEFT SPEAKER

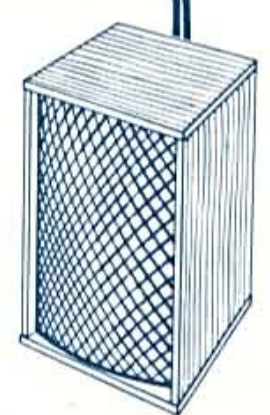

RIGHT SPEAKER

== LEFT CHANNEL
— RIGHT CHANNEL

OPERATION / SIMPLE MAINTENANCE HINTS

FM Reception

1. Set the Selector Control to FM AUTO.
2. Tune in the desired station by turning the Tuning Control. It is pinpointed when the Signal Meter pointer has swung as far to the right as possible and the Tuning Meter pointer is accurately centered.
3. Turn the Output Level Control as required.

Note:

1. If a stereo broadcast is too noisy, push the Noise Suppressor Switch down to IN. If noise still persists, turn the Selector Control to FM MONO and hear the broadcast in mono.
2. When receiving a stereo broadcast, be sure that the mode switch of your amplifier is also set to a stereo mode.

AM Reception

1. Set the Selector Control to AM.
2. Select the desired station by adjusting the Tuning Control so that the Signal Meter pointer will swing as far to the right as it will go near the frequency of that station.
3. Turn the Output Level Control as required.

Note: If the broadcast is too noisy, push the Noise Suppressor Switch down to IN.

Important

As a rule, it is better to use the Output Level Control to match the tuner's output signal level with those of your turntable and tape deck, then adjust the over-all volume with the volume control of your amplifier.

Rear-Panel AC Outlet

The AC outlet on the rear panel is always live and has a power capacity of 150VA. Its voltage is the same as the power supply voltage used.

Before you connect any appliance to it, be sure that it is adjusted for use at the same voltage and that its power consumption is not more than 150VA.



Muting Level Control

This rear-panel control adjusts the working level of the FM muting circuit. Normally there is no need to touch it, but adjust it in these instances:

1. Turn it counterclockwise if the desired FM station(s) is cut off and cannot be received when you turn on the FM Muting Switch.
2. Turn it clockwise if you wish to receive only strong stations.



FM Local/Distant Antenna Switch

Should you happen to live near a broadcast station, the radio wave from it may be excessively strong and the received broadcast sound may be distorted.

In such a case, change this switch to LOC, and the distortion will normally disappear, giving you a pleasant reception. Otherwise leave the switch at DIST.



Discriminator Output Terminals

Four-channel stereo is fast becoming popular as a means of reproducing the live sound field. Four-channel stereo FM broadcasts are already underway in some areas of the world using matrix four-channel systems, but the discrete 4-channel system will also be introduced to FM in the near future.

To receive discrete 4-channel stereo FM broadcasts, you will need an adaptor in addition to the TU-7500. The DISCRIMINATOR OUTPUT terminal on the tuner's rear panel is for connecting such adaptor.



Should the Power Fuse Blow

If the dial fails to glow and the tuner remains dead when you turn on the Power Switch, it is possible that its power fuse has blown.

Should this happen, disconnect the power cord from the wall AC outlet at once and examine the power fuse on the rear panel. If you find it blown, find out the cause of the blowout and eliminate it, then replace the blown fuse with a new glass-tubed fuse of the rated capacity (1-ampere for 100/117 volt operation, 0.5-ampere for 220/240 volt operation). Never use a fuse of a different capacity or a piece of wire, even as a stopgap measure, or serious danger could result.



Voltage Adjustment

The TU-7500 is equipped with a Voltage Selector so that it may be used anywhere in the world. It is set to the correct voltage of your area prior to shipment from our factory, and there is no need to touch it. But if you move after purchasing the tuner and find the power supply voltage is different, reset the selector as follows:

1. Remove the two screws securing the name plate on the rear panel, then remove the name plate.
2. Unplug the Voltage Selector once, and reset it so that the arrow mark on it faces the correct voltage indication.
3. Change the power fuse as well whenever the voltage has changed. For 100-117 volt operation, use a 1-ampere glass-tubed fuse. For 220-240 volt operation, use a 0.5-ampere one.
4. Where the power supply voltage considerably fluctuates, the Voltage Selector may be reset to avoid the unpleasant side effects of such fluctuation. Reset it to the voltage immediately higher than the peak of the fluctuation.

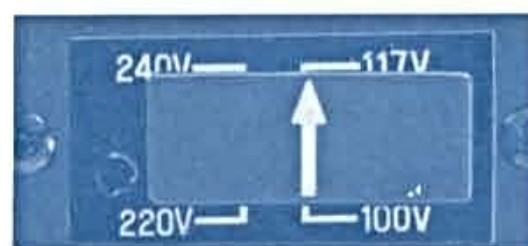

Servicing

Should anything ever go wrong with your TU-7500 or if you have any question about it, please contact the Sansui dealer from whom you purchased it or your nearest Authorized Sansui Service Station.

GENERAL TROUBLESHOOTING CHART

Many of the troubles which seem to be a fault of the tuner may be caused by wrong operation or by outside devices. These can be easily corrected by simple checking and easy remedies. If you notice a condition which looks like a breakdown of the tuner, examine the various connections and your operat-

ing procedure once, then look up the condition in the following chart to see if it cannot be easily removed. If this fails to improve the situation and the tuner definitely seems faulty, please contact the Sansui dealer from whom you purchased the tuner or your nearest Authorized Sansui Service Station.

PROGRAM	SYMPTOM	PROBABLE CAUSE	WHAT TO DO
AM, FM or MPX reception	<ul style="list-style-type: none"> • Constant or intermittent noise heard at times or in certain areas. 	<ul style="list-style-type: none"> * Discharge or oscillation caused by electrical appliances, such as fluorescent lamp, TV set, D.C. motor, rectifier or oscillator. * Natural phenomena, such as atmospheric, static or thunderbolts. * Insufficient antenna input due to ferroconcrete wall or long distance from station. 	<ul style="list-style-type: none"> * Attach noise limiter to electrical appliance producing noise, or attach it to tuner's power source. * Install outdoor antenna and ground tuner to raise S/N ratio. * Reverse power cord plug/receptacle connections. * If noise occurs at certain frequency, attach wave trap to input. * Keep tuner at proper distance from other electrical appliances.
FM reception	<ul style="list-style-type: none"> • Noisy. <p>Note: FM reception is affected considerably by transmitting conditions of station, such as power and antenna efficiency. As a result, you may receive one station quite well while receiving another station poorly.</p>	<ul style="list-style-type: none"> * Poor noise limiter effect or too low S/N ratio due to insufficient antenna input. 	<ul style="list-style-type: none"> * Install antenna (supplied) for maximum signal strength. * If this does not prove effective, use exclusive FM outdoor antenna. * Excessively long lead-in wire of antenna may cause noise.
	<ul style="list-style-type: none"> • A series of pops. 	<ul style="list-style-type: none"> * Ignition noise caused by starting of nearby automobile engine. 	<ul style="list-style-type: none"> * Install antenna and its lead-in wire at proper distance from street or increase antenna input.
	<ul style="list-style-type: none"> • Tuning noise between stations. 	<ul style="list-style-type: none"> * Results from nature of FM reception. * FM Muting Switch at OFF. 	<ul style="list-style-type: none"> * Turn on FM Muting Switch. * Ditto.
FM-MPX reception	<ul style="list-style-type: none"> • Noise heard during FM-MPX reception but not during FM mono reception. 	<ul style="list-style-type: none"> * Weaker signal because service area of FM-MPX broadcast is only half that of FM mono broadcast. 	<ul style="list-style-type: none"> * Orient antenna for maximum antenna input. * Set Noise Suppressor Switch to IN position.
AM reception	<ul style="list-style-type: none"> • Noise heard at particular time of day, in certain area or over part of dial. 	<ul style="list-style-type: none"> * Peculiar to AM broadcasts. 	<ul style="list-style-type: none"> * Install antenna for maximum antenna efficiency. See 'AM Antennas'. * Set Noise Suppressor Switch to IN position. * In some cases, noise can be eliminated by grounding tuner or reversing power cord plug/receptacle connections.
	<ul style="list-style-type: none"> • High-frequency noise. 	<ul style="list-style-type: none"> * Beat interference by adjacent station. * TV set too close to stereo system. 	<ul style="list-style-type: none"> * Turn on amplifier's High Filter. * Set Noise Suppressor Switch to IN position. * Keep TV set at proper distance from stereo system.

SPECIFICATIONS/ACCESSORIES

FM SECTION

TUNING RANGE: 88 to 108MHz
 SENSITIVITY (IHF): 1.9 μ V
 TOTAL HARMONIC DISTORTION
 (MONO): less than 0.3%
 (STEREO): less than 0.5%
 SIGNAL TO NOISE RATIO:
 better than 70dB
 SELECTIVITY: better than 70dB
 CAPTURE RATIO (IHF): 2dB
 IMAGE FREQUENCY REJECTION:
 better than 75dB at 98MHz
 IF REJECTION: better than 90dB
 SPURIOUS RESPONSE REJECTION:
 better than 80dB
 STEREO SEPARATION: better than 40dB at 400Hz
 SPURIOUS RADIATION: less than 34dB
 ANTENNA INPUT IMPEDANCE:
 300 Ω balanced,
 75 Ω unbalanced
 ANTENNA ATT.: 20dB
 FREQUENCY RESPONSE (STEREO):
 30 to 15,000Hz +0.5dB, -2.5dB

AM SECTION

TUNING RANGE: 535 to 1,605kHz
 SENSITIVITY (Bar Antenna):
 50dB/m
 SELECTIVITY (± 10 kHz): better than 25dB
 IMAGE FREQUENCY REJECTION:
 better than 80dB/m at 1,000kHz
 IF REJECTION: better than 80dB/m at 1,000kHz
 OUTPUT: 0 to 1V
 REC OUTPUT: 0.3V
 CONTROLS AND SWITCHES:
 SELECTOR: AM, FM AUTO, FM MONO
 FM MUTING: ON, OFF
 NOISE SUPPRESSOR: OUT, IN
 FM ATT. SWITCH LOCAL, DISTANT
 SEMICONDUCTORS: 39 Transistors, 3 FETs, 21 Diodes,
 3 ICs
 POWER REQUIREMENTS:
 POWER VOLTAGE: 100, 117, 220, 240V 50/60Hz
 POWER CONSUMPTION: 20W
 DIMENSIONS: 440mm, 17 $\frac{3}{8}$ " W.
 140mm, 5 $\frac{9}{16}$ " H.
 322mm, 12 $\frac{11}{16}$ " D.
 WEIGHT: 8.0kg (17.6 lbs)

ACCESSORIES

1. FM Antenna.....	1
2. AM Antenna.....	1
3. Connection Cable with Pin Plugs	2
4. Polishing Cloth	1
5. Butterfly Bolts.....	2
6. Washers	2
7. Operating Instructions and Service Manual	1
8. Operating Instructions Sheet	1

DISASSEMBLY PROCEDURE

REMOVING FRONT PANEL, METAL BONNET AND BOTTOM BOARD

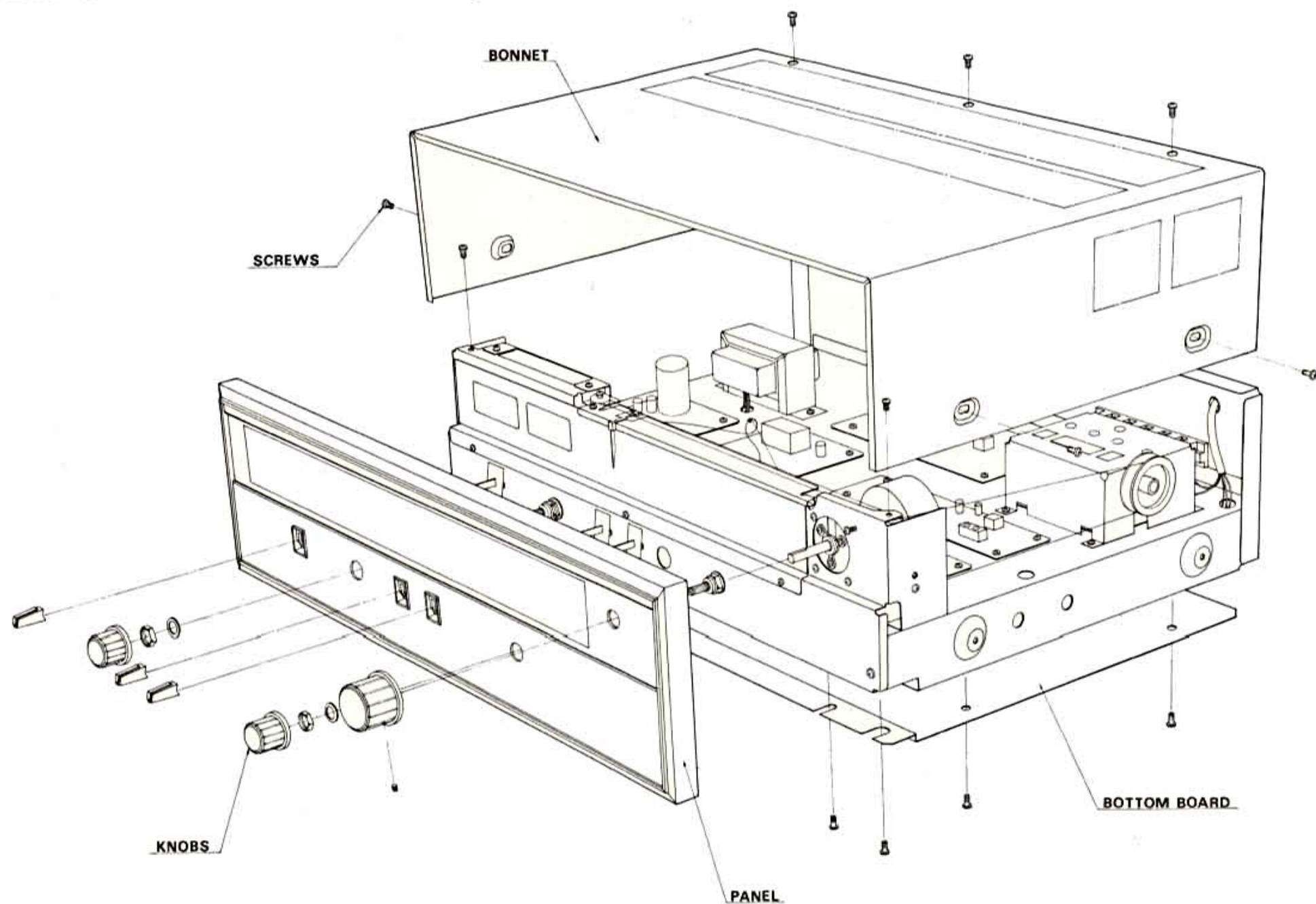

DIAL MECHANISM

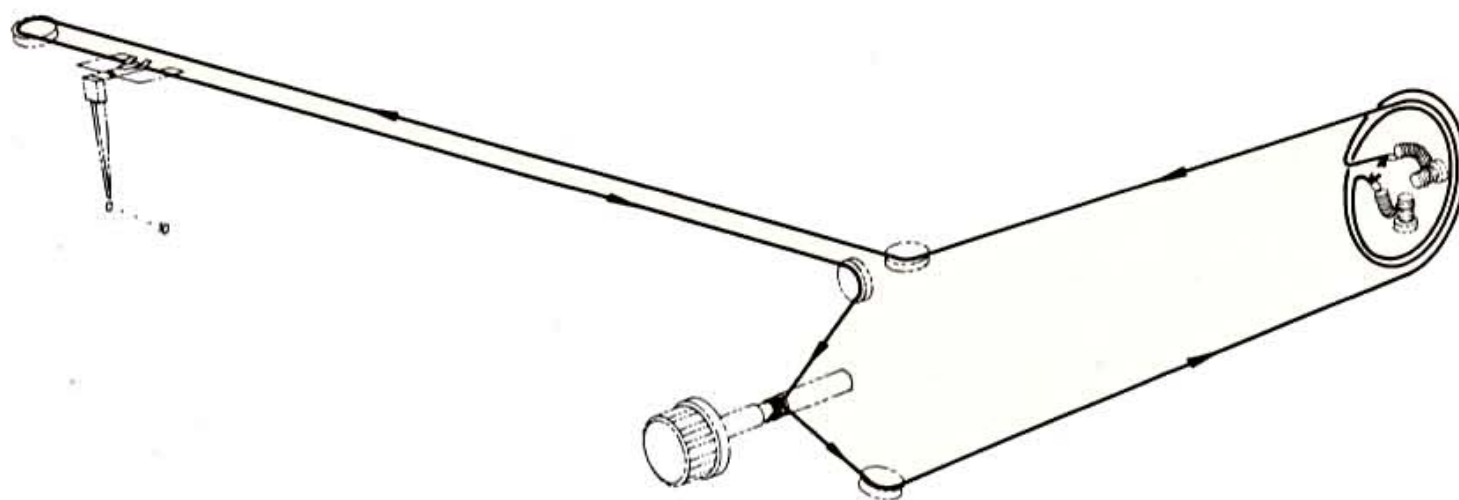

TEST POINTS

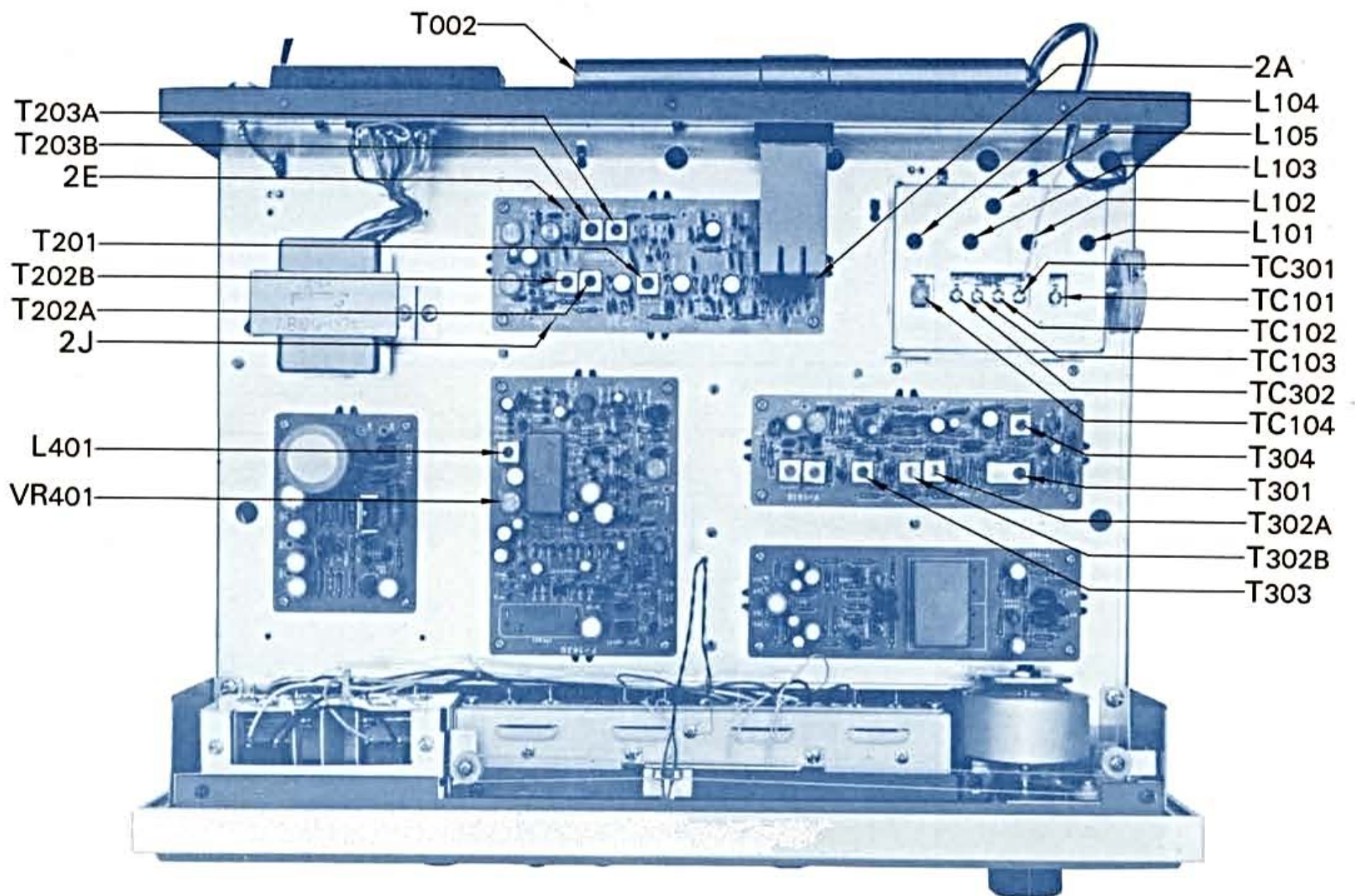

SCHEMATIC DIAGRAM

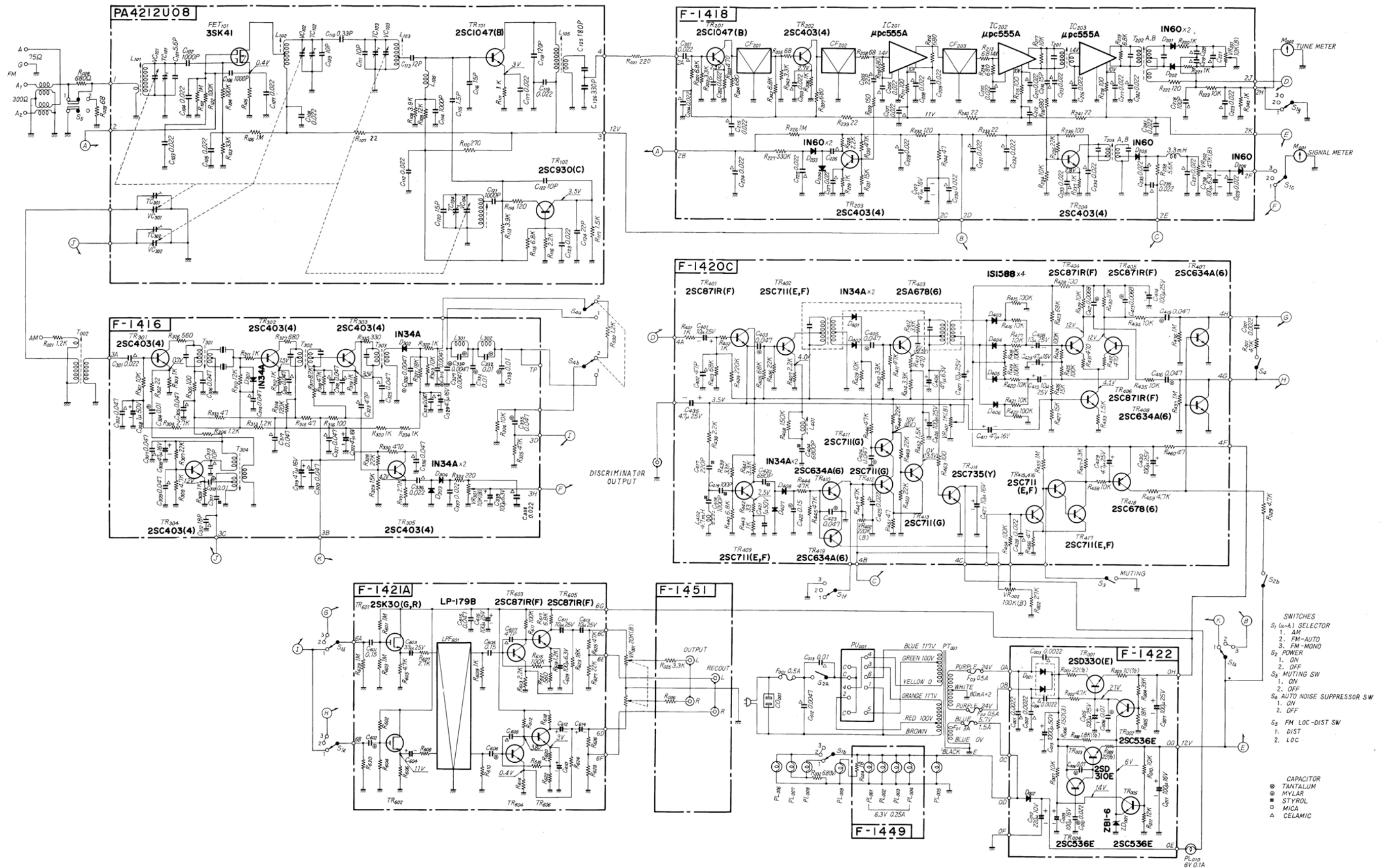

ALIGNMENT

FM TUNER SECTION

STEP	FEED SIGNAL		MEASURE OUTPUT		SET TUNING CONTROL TO	ADJUST	ADJUST FOR
	FROM	TO	AT	WITH			
1.	Sweep generator 10.7MHz \pm 200kHz (output 60dB)	2A (via 10pF ceramic capacitor)	2J	Oscilloscope		T _{202A, B}	S curve
2.	Sweep generator 10.7MHz \pm 200kHz (output at limiter point)	2A (via 10pF ceramic capacitor)	2E	Oscilloscope		T _{203A, B}	Match centers of S curve and output waveform of meter (see Fig. 1)
3.	FM signal generator 98MHz (400Hz 100% mod., output 60dB)	Antenna terminal	Output terminal	Oscilloscope & V.T.V.M.	98MHz	L ₁₀₅ , T ₂₀₁	Max. output
4.	FM signal generator 98MHz (400Hz 100% mod., output at limiter point)	Antenna terminal	Output terminal	Oscilloscope & distortion meter	98MHz	T _{202A}	Min. distortion factor
5.	FM signal generator 88MHz (400Hz 100% mod.)	Antenna terminal	Output terminal	Oscilloscope & V.T.V.M.	88MHz	L ₁₀₄	Max. output
6.	FM signal generator 108MHz (400Hz 100% mod.)	Antenna terminal	Output terminal	Oscilloscope & V.T.V.M.	108MHz	TC ₁₀₄	Max. output
7.	Repeat steps 5, 6						
8.	FM signal generator 90MHz (400Hz 100% mod.)	Antenna terminal	Output terminal	Oscilloscope & V.T.V.M.	90MHz	L _{101, 102, 103}	Max. output
9.	FM signal generator 106MHz (400Hz 100% mod.)	Antenna terminal	Output terminal	Oscilloscope & V.T.V.M.	106MHz	TC _{101, 102, 103}	Max. output
10.	Repeat steps 8, 9						

FM MPX SECTION

STEP	FEED SIGNAL		MEASURE OUTPUT		SET TUNING CONTROL TO	ADJUST	ADJUST FOR
	FROM	TO	AT	WITH			
1.	FM signal generator 84MHz & stereo signal generator (composite signal containing pilot signal, L ch. 40% mod.)	Antenna terminal	Output terminal (L ch.)	Oscilloscope, V.T.V.M. & distortion meter	84MHz	L ₄₀₁	Turn VR ₄₀₁ fully counterclockwise. Max. output, Min. distortion in L ch.
2.	FM signal generator 84MHz & stereo signal generator (composite signal containing pilot signal, L ch. 40% mod.)	Antenna terminal	Output terminal (R ch.)	Oscilloscope & V.T.V.M.	84MHz	VR ₄₀₁	Min. output in R ch.

AM TUNER SECTION

STEP	FEED SIGNAL		MEASURE OUTPUT		SET TUNING CONTROL TO	ADJUST	ADJUST FOR
	FROM	TO	AT	WITH			
1.	Sweep generator 455kHz \pm 30kHz	Antenna terminal	TP (F-1416)	Oscilloscope	Any frequency not occupied by broadcast stations	T _{301, 302A, 302B, 303}	Best AM IF waveform (set Noise Suppressor SW to IN)
2.	AM signal generator 535kHz (400Hz 30% mod.)	Antenna terminal	Output terminal	Oscilloscope & V.T.V.M.	535kHz	T ₃₀₄	Max. output
3.	AM signal generator 1600kHz (400Hz 30% mod.)	Antenna terminal	Output terminal	Oscilloscope & V.T.V.M.	1600kHz	TC ₃₀₂	Max. output
4.	Repeat steps 2, 3						
5.	AM signal generator 600kHz (400Hz 30% mod.)	Antenna terminal	Output terminal	Oscilloscope & V.T.V.M.	600kHz	T ₀₀₂	Max. output
6.	AM signal generator 1400kHz (400Hz 30% mod.)	Antenna terminal	Output terminal	Oscilloscope & V.T.V.M.	1400kHz	TC ₃₀₁	Max. output
7.	Repeat steps 5, 6						

FM DISCRIMINATOR WAVEFORM

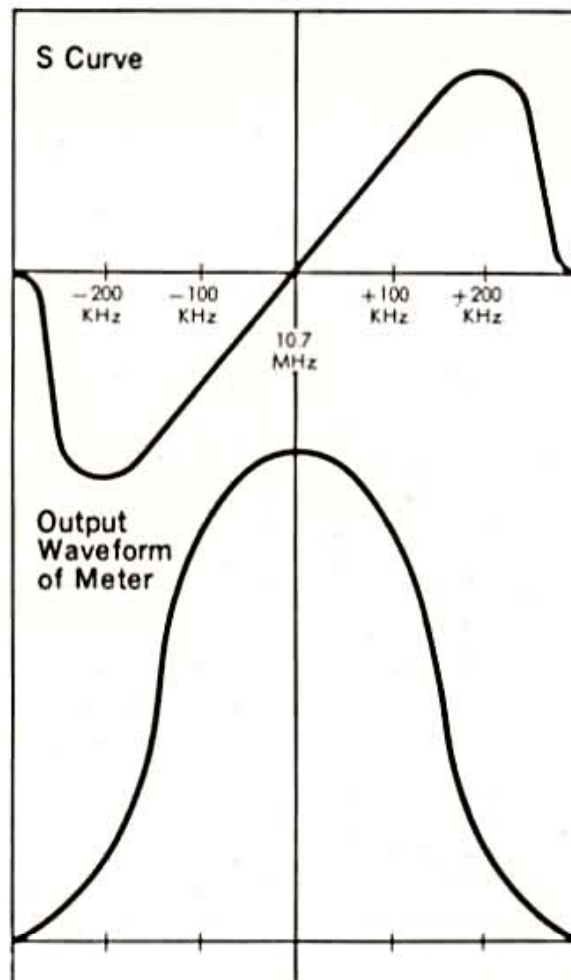

Fig. 1

OUTPUT WAVEFORM OF METER

AM IF WAVEFORM

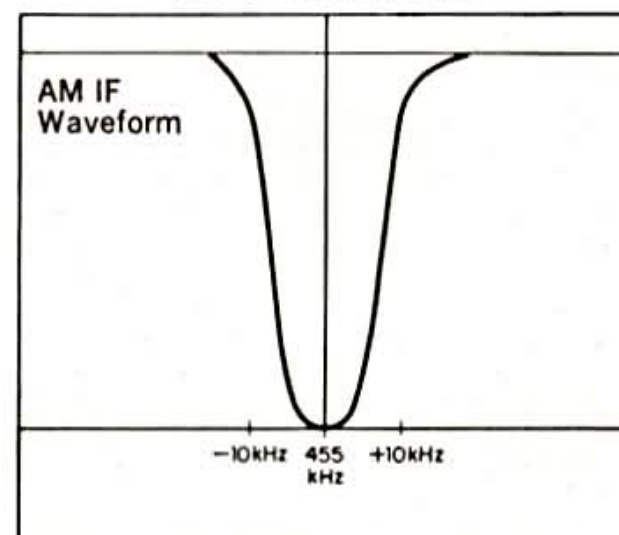

Fig. 2

PRINTED CIRCUIT BOARDS AND PARTS LIST

W: Parts No. X: Parts Name Y: Stock No. Z: Position of Parts

FM IF BLOCK <F-1418>

Stock No. 7520540

W	X	Y	Z
R201	6.8kΩ	0106682	1 A
R202	3.3kΩ	0106332	1 A
R203	470Ω	0106471	1, 2 A
R204	680Ω	0106681	1 A
R205	68Ω	0106680	1 A
R206	1kΩ	0106102	1, 2 A
R207	680Ω	0106681	1 A
R208	68Ω	0106680	1 A
R209	150Ω	0106151	2 A
R210	680Ω	0106681	1 A
R211	100Ω	0106101	1 A
R212	680Ω	0106681	1 A
R213	68Ω	0106680	1 B
R214	680Ω	0106681	1 B
R215	100Ω	0106101	1 B
R216	680Ω	0106681	1, 2 B
R217	10kΩ	0106103	1 B
R218	100Ω	0106101	1 B
R219	6.8kΩ	0106682	1 B
R220	1kΩ	0106102	1 C
R221	1kΩ	0106102	1 C
R222	120Ω	0107121	1 C
R223	10kΩ	0106103	1 C
R224	2.2Ω	0107229	1 C
R226	1MΩ	0107105	2 A
R227	330kΩ	0106334	2 A
R228	2.2kΩ	0106222	2 A
R229	1kΩ	0106102	2 A
R230	47kΩ	0106473	2 A
R231	15kΩ	0106153	2 A
R232	120Ω	0107121	2 A
R233	22Ω	0107220	2 B
R234	10kΩ	0106103	2 B
R235	22kΩ	0106223	2 B
R236	100Ω	0106101	2 B
R237	1kΩ	0106102	2 B
R238	5.6kΩ	0106562	2 C
R239	22Ω	0107220	1 A
R240	22Ω	0107220	1 A, B
R241	22Ω	0107220	1 B
R242	6.8kΩ	0106682	1 A
R243	3.3kΩ	0106232	1 A
R244	47Ω	0106470	2 B
R245	1kΩ	0107102	
VR201	10kΩ(B) FM Tuning Meter Adj.	1935130	1 C
VR202	47kΩ(B) FM Signal Meter Adj.	1935170	2 C
C201	0.022μF	0656223	1 A
C202	0.022μF	0656223	1, 2 A
C203	0.022μF	0656223	1, 2 A
C204	0.022μF	0656223	1 A
C205	22pF ±10%	0660220	1, 2 A
C206	0.022μF	0656223	1, 2 A
C207	0.022μF	0656223	1 A
C208	0.022μF	0656223	1 A
C209	0.022μF	0656223	1 A

± 5% ¼W CR.

W	X	Y	Z
C210	0.022μF	0656223	1, 2 B
C211	0.022μF	0656223	1 B
C212	0.022μF	0656223	1 B
C213	0.022μF	0656223	1 B
C214	15pF ±10%	0660150	2 B
C215	0.022μF	0656223	1 A
C216	0.022μF	0656223	1, 2 B
C217	0.022μF	0656223	1 B
C218	100pF	0660101	1 C
C219	220pF	0660221	1 C
C220	220pF	0660221	1 C
C221	10μF	0512100	2 C
C222	47μF	0512470	2 A, B
C223	0.022μF	0656223	1 C
C224	0.022μF	0656223	1, 2 A
C225	0.022μF	0656223	2 A
C226	0.001μF ±80%	0657102	2 A
C227	0.022μF	0656223	2 A
C228	0.022μF	0656223	2 A
C229	0.022μF	0656223	2 C
C230	0.022μF	0656223	2 B
C231	0.022μF	0656223	2 B
C232	0.022μF	0656223	2 B
C233	0.022μF	0656223	2 B
C234	0.022μF	0656223	2 C
C235	0.022μF	0656223	2 C
C236	0.022μF	0656223	2 C
C237	0.022μF	0656223	2 C
C238	100μF	0510101	1, 2 C
C240	0.022μF ±80%	0656223	
TR201	25C1047 (B)	0305801	1 A
TR202		0305992	1 A
TR203	25C403C (4)	0305992	2 B
TR204		0305992	2 B
IC201		0360070	1 A
IC202	μPC555A	0360070	1 B
IC203		0360070	1 B
D201	IN60P	0311050	1 C
D202	IN60P	0311050	1 C
D203		0310332	2 A
D204	IN60	0310332	2 A
D205		0310332	2 C
D206	DS430	0340090	2 C
T201		4235860	1 B
T202A		4235750	1 C
T202B	FM IF Coil	4235760	2 B, C
T203A		4235840	2 C
T203B		4235850	2 C
L201	33mH Micro Inductor	4900180	2 C
CF201		0910150	1 A
CF202	SFE-10.7MA	0910150	1 A
CF203		0910150	1 B
	F-1418 Printed Circuit Board	2520330	

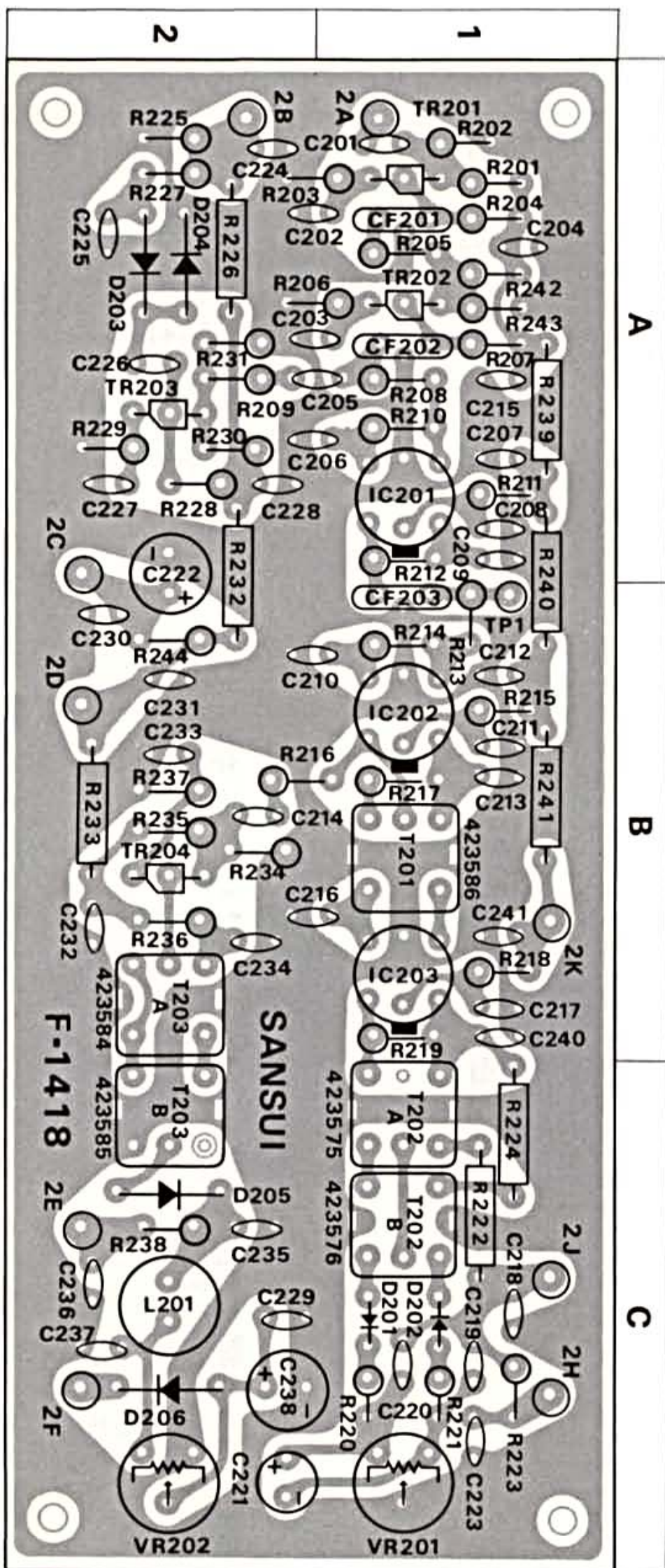

Abbreviations	
CR	: Carbon Resister
CC	: Ceramic Capacitor
EC	: Electrolytic Capacitor
MC	: Mylar Capacitor
SC	: Styrol Capacitor

PRINTED CIRCUIT BOARDS AND PARTS LIST

W: Parts No. X: Parts Name Y: Stock No. Z: Position of Parts

FM MPX BLOCK <F-1420C>

Stock No. 7540690

W	X	Y	Z
R401	1kΩ	0106102	2C
R402	1kΩ	0106102	1B
R403	68kΩ	0106683	2C
R404	220kΩ	0106224	1C
R405	68kΩ	0106683	1C
R406	22kΩ	0106223	1C
R407	2.2kΩ	0106222	1C
R408	150kΩ	0106154	1C
R409	10kΩ	0106103	2C
R410	33kΩ	0106333	2C
R411	47kΩ	0106473	2C
R412	33kΩ	0106333	2B, C
R413	470Ω	0106471	2B
R414	3.3kΩ	0106332	2C
R415	100kΩ	0106104	2B
R416	10kΩ	0106103	2B
R417	10kΩ	0106103	2B
R418	100kΩ	0106104	2B
R419	100kΩ	0106104	2B
R420	10kΩ	0106103	1, 2B
R421	10kΩ	0106103	1B
R422	100kΩ	0106104	1B
R423	68kΩ	0106683	2B
R424	100kΩ	0106104	2A
R425	100kΩ	0106104	1, 2A
R426	15kΩ	0106153	1A, B
R427	15kΩ	0106153	1B
R428	100Ω	0106101	2A
R429	10kΩ	0106103	2A
R430	10kΩ	0106103	1A
R431	470Ω	0106471	2A
R432	470Ω	0106471	1A
R433	1.8kΩ	0106182	1A
R434	10kΩ	0106103	1A
R435	10kΩ	0106103	2A
R436	1MΩ	0106105	3A
R437	1MΩ	0106105	3A
R438	2.2kΩ	0106222	1A
R439	33kΩ	0106333	2A
R440	6.8kΩ	0106682	2A
R441	3.3kΩ	0106332	3A
R442	33Ω	0106330	3A
R443	1kΩ	0106102	2, 3C
R444	47kΩ	0106473	3C
R445	47kΩ	0106473	3C
R446	47kΩ	0106473	3C
R447	47kΩ	0106473	3B
R448	22kΩ	0106223	3C
R449	22kΩ	0106223	3B, C
R450	22kΩ	0106223	3B
R451	47Ω	0106470	3B
R452	1.5kΩ	0106152	2B
R453	100Ω	0106101	2, 3B
R454	100kΩ	0106104	3B
R455	1MΩ	0106105	3B
R456	47Ω	0106470	3A, B

W	X	Y	Z
R457	3.3kΩ	0106332	3B
R458	10kΩ	0106103	3A, B
R459	4.7kΩ	0106472	3A
R460	47Ω	0106470	2, 2A
VR401	1kΩ(B) Stereo Separation Adj.	1035070	1B
VR402	220kΩ(B) FM Muting Adj.	1035210	3B, C
C401	10μF 25V EC.	0513100	2C
C402	47pF ±10% 50V CC.	0660470	2C
C403	0.047μF ±10% 50V MC.	0601477	1C
C404	6800pF ±5% 50V SC.	0629001	1B, C
C405	0.047μF ±10% 50V MC.	0601477	2, 3C
C406	47μF 6.3V EC.	0510470	2B
C407	10μF } 25V EC.	0513100	1B
C408	10μF }	0513100	2A, B
C409	47μF 16V EC.	0512470	1A, B
C410	10μF 25V EC.	0513100	1B
C411	47μF 16V EC.	0512470	1B
C412	0.0082μF } ±5% 50V MC.	0600826	2A
C413	0.0082μF }	0600826	2A
C414	100μF 25V EC.	0513101	2A
C415	0.047μF } ±10% 50V MC.	0601477	3A
C416	0.047μF }	0601477	3A
C417	220pF	0620221	2C
C418	1000pF } ±5% 50V SC.	0620102	2C
C419	100pF }	0620101	2C
C420	680pF	0620681	3C
C421	1μF 50V EC.	0515109	3C
C422	0.15μF } ±10% 50V MC.	0601158	3C
C423	0.047μF }	0601477	3C
C424	0.047μF }	0601477	3C
C425	0.022μF +80% -20% 50V CC.	0657223	3B
C426	100μF 25V EC.	0513101	2B
C427	10μF 16V EC.	0512100	3B
C428	0.022μF +80% -20% 50V CC.	0657223	3B
C429	4.7μF } 25V EC.	0513479	3B
C430	100μF }	0513101	2, 3B
C435	4.7μF }	0513479	
TR401	2SC871R (F)	0305475	1C
TR402	2SC711 (E, F)	0306731, 2	1C
TR403	2SA678 (6)	0300291	2B
TR404		0305475	2A
TR405	2SC871R (F)	0305475	1A
TR406		0305475	1A
TR407		0305891	3A
TR408	2SC634A(6)	0305891	3A
TR409	2SC711 (E, F)	0305731, 2	2, 3C
TR410	2SC634A (6)	0305891	3B, C
TR411		0305733	3C
TR412	2SC711 (G)	0305733	3B
TR413		0305733	2B, C
TR414	2SC735 (Y)	0305641	3B, C
TR415		0305731, 2	3B
TR416	2SC711 (E, F)	0305731, 2	3B
TR417		0305731, 2	3A

PRINTED CIRCUIT BOARDS AND PARTS LIST

W: Parts No. X: Parts Name Y: Stock No. Z: Position of Parts

AM BLOCK <F-1416>

Stock No. 7530240

W	X	Y	Z
R301	10kΩ	0107103	1 A
R302	22Ω	0107220	1 A
R303	1kΩ	0107102	1 A
R304	2.7kΩ	0107272	2 A
R305	100Ω	0107101	2 A
R306	1.2kΩ	0107122	2 A
R307	22kΩ	0107223	2 A
R308	4.7kΩ	0107472	2 A
R309	1kΩ	0107102	2 A
R310	12kΩ	0107123	1 A, B
R311	1kΩ	0107102	1 B
R312	1kΩ	0107102	1 B
R313	1.2kΩ	0107122	2 B
R314	120kΩ	0107124	2 B, C
R315	47Ω	0107470	2 B
R316	100Ω	0107101	2 B
R317	8.2kΩ	0107822	1 B
R318	4.7kΩ	0107472	1 B
R319	1kΩ	0107102	1 B, C
R320	1kΩ	0107102	2 B
R321	18kΩ	0107183	2 B, C
R322	1kΩ	0107002	2 C
R323	10kΩ	0107103	1 C
R324	10kΩ	0107103	1 C
R325	47kΩ	0107473	1, 2 C
R326	560Ω	0107561	1 A
R327	680Ω	0107681	1 B
R328	22kΩ	0107223	2 B
R329	15kΩ	0107153	2 B
R330	470Ω	0107471	2 B
R331	2.7kΩ	0107272	2 B, C
R332	220Ω	0107221	2 C
R333	47Ω	0107470	2 A, B
R334	1kΩ	0107102	2 B
R335	330Ω	0106331	1 B
R337	47Ω	0107470	
VR301	10kΩ(B) AM Meter Adj.	1035130	2 C
C301	0.022μF } +80% 25V CC.	0656223	1 A
C302	0.047μF } -20%	0656473	1 A
C303	1μF	0515109	2 A
C304	0.01μF ±10%	0601107	1, 2 A
C305	0.047μF	0656473	1 A
C306	0.047μF } +80% 25V CC.	0656473	1 A
C307	0.047μF } -20%	0651473	2 A
C308	47μF	0512470	2 A
C309	0.047μF } +80% 25V CC.	0656473	2 A
C310	0.01μF ±10%	0601107	2 A
C311	360pF ±5%	0621361	2 A
C312	18pF ±10%	0660180	2 A
C313	10pF ±10%	0660100	2 A
C314	0.047μF } +80% 25V CC.	0656473	2 A, B
C315	0.047μF } -20%	0656473	1 B
C316	0.0047μF ±10%	0601476	2 C

W	X	Y	Z
C317	0.047μF } +80% 25V CC.	0656473	1 B
C318	0.047μF } -20%	0656473	1 B
C319	47μF	0512470	2 B
C320	0.047μF } +80% 25V CC.	0656473	2 B
C321	0.047μF } -20%	0656473	2 B
C322	1μF	0515109	2 B
C323	47pF ±10%	0660470	1, 2 B
C324	0.047μF } +80% 25V CC.	0656473	1 B
C325	0.047μF } -20%	0656473	1 B
C326	0.0047μF } +80% 50V MC.	0601476	1 C
C327	0.0047μF } -20%	0601476	2 C
C328	0.047μF } +80% 25V CC.	0656473	2 B
C329	4.7μF	0513479	2 B
C330	0.0047μF	0601476	1 C
C331	0.01μF	0601107	1, 2 C
C332	0.01μF } ±10% 50V MC.	0601107	1, 2 C
C333	0.01μF	0601107	2 C
C334	0.047μF	0601477	2 C
C335	0.047μF	0656473	2 B
C336	0.047μF } +80% 25V CC.	0656473	2 B
C337	0.022μF } -20%	0656223	2 C
C338	0.022μF	0656223	2 C
C339	100μF	0510101	2 C
TR301		0305992	1 A
TR302	25C403C (4)	0305992	1 B
TR303		0305992	1 B
TR304		0305991	2 A
TR305	25C403C (3)	0305991	2 B
D301		0310400	1 A
D302	IN34A	0310400	1 C
D303		0310400	2 C
D304		0310400	2 C
T301		YEL-455E ₂ Ceramic Filter	0910180
T302A	AM IF Coil	4230590	1 B
T302B		4230600	1 B
T303		4230580	1 B, C
T304		4220380	2 A
L301	59mH Filter Coil	4290200	1 C
L302		4290200	1 C
	F-1416 Printed Circuit Board	2530140	

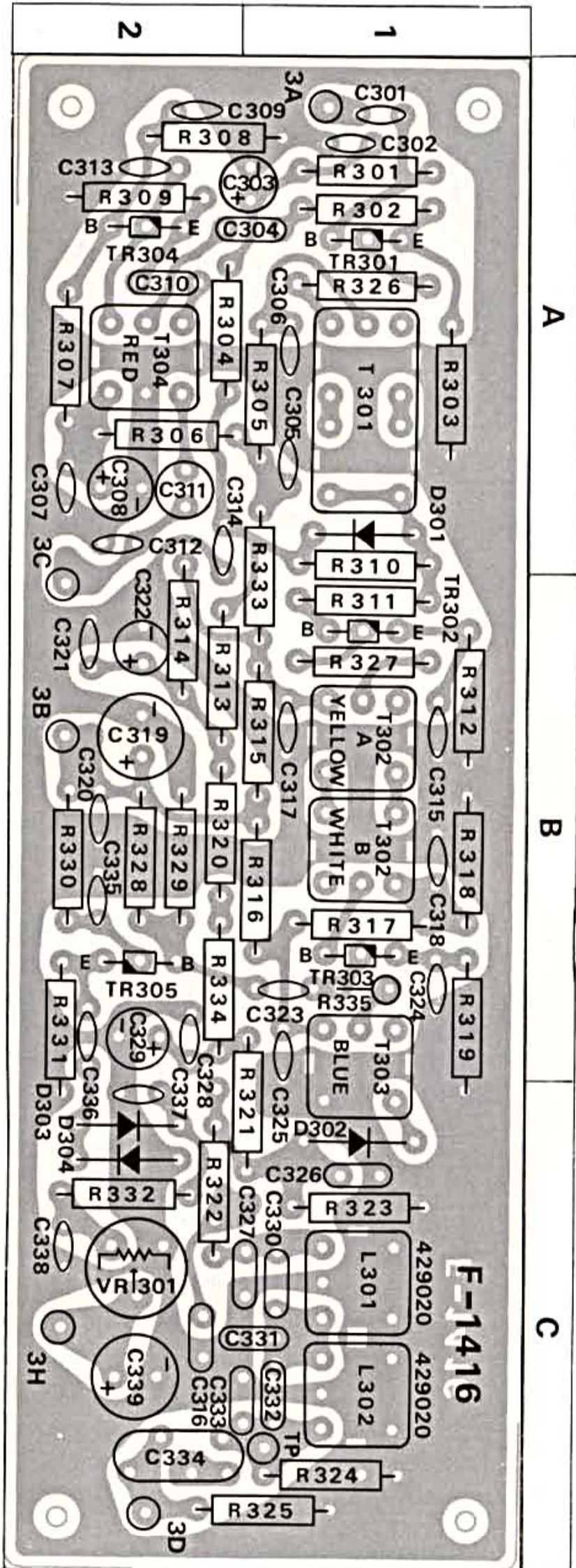

LAMP HOLDER BLOCK <F-1449>

Stock No. 7591210

W	X	Y
R024	18Ω ± 5% ¼W CR.	0107180
PL001	6.3V 0.25A } Dial Scale Lamp.	0420020
PL002		0420020
PL003		0420020
PL004		0420020
	Fuse Holder (× 8)	2310051
	F-1449 Printed Circuit Board	2591210

TERMINAL BLOCK <F-1451>

Stock No. 7591220

W	X	Y
R025	3.3kΩ } ± 5% ¼W CR.	0107332
R026		0107332
	F-1451 Printed Circuit Board	2591220

PRINTED CIRCUIT BOARDS AND PARTS LIST

W: Parts No. X: Parts Name Y: Stock No. Z: Position of Parts

FILTER BLOCK <F-1421A>

Stock No. 7591200

W	X	Y	Z
R601	1MΩ	0107105	1A
R602	1MΩ	0107105	2A
R603	1MΩ	0107105	1A
R604	1MΩ	0107105	2A
R605	4.7kΩ	0107472	1A
R606	4.7kΩ	0107472	2A
R607	2.7kΩ	0107272	1A
R608	2.7kΩ	0107272	2A
R609	1kΩ	0107102	1C
R610	1kΩ	0107102	2C
R611	100kΩ	0107104	1C
R612	100kΩ	0107104	2C
R613	2.2kΩ	0107222	1C
R614	2.2kΩ	0107222	2C
R615	100kΩ	0107104	1C
R616	100kΩ	0107104	2C
R617	6.8kΩ	0107682	1D
R618	6.8kΩ	0107682	2D
R619	1.2kΩ	0107122	1C
R620	1.2kΩ	0107122	2C
R621	560Ω	0107561	1D
R622	560Ω	0107561	2D
R623	18kΩ	0107183	1C, D
R624	18kΩ	0107183	2C, D
R625	47kΩ	0107473	1D
R626	47kΩ	0107473	2D
R627	22kΩ	0107223	1D
R628	22kΩ	0107223	2D
R629	1MΩ	0107105	1A
R630	1MΩ	0107105	2A
C601	0.15μF	0601158	1A
C602	0.15μF	0601158	2A
C603	33μF	0513330	1A
C604	33μF	0513330	2A
C605	0.15μF	0601158	1C
C606	0.15μF	0601158	2C
C607	47pF	0660470	1C
C608	47pF	0660470	2C
C609	100μF	0510101	1D
C610	100μF	0510101	2D
C611	10μF	0513100	1D
C612	10μF	0513100	2D
C613	10μF	0513100	1D
C614	10μF	0513100	2D
C615	0.047μF	0601477	1A
C616	100μF	0513101	1, 2D
TR601	2SK30 (GR) 2SC871R (F)	0370103	1A
TR602		0370103	2A
TR603		0305475	1C
TR604		0305475	2C
TR605		0305475	1C
TR606		0305475	2C
LPF601	Low Pass Filter LP-179B	0910170	1, 2B, C
	F-1421 Printed Circuit Board	2591190	

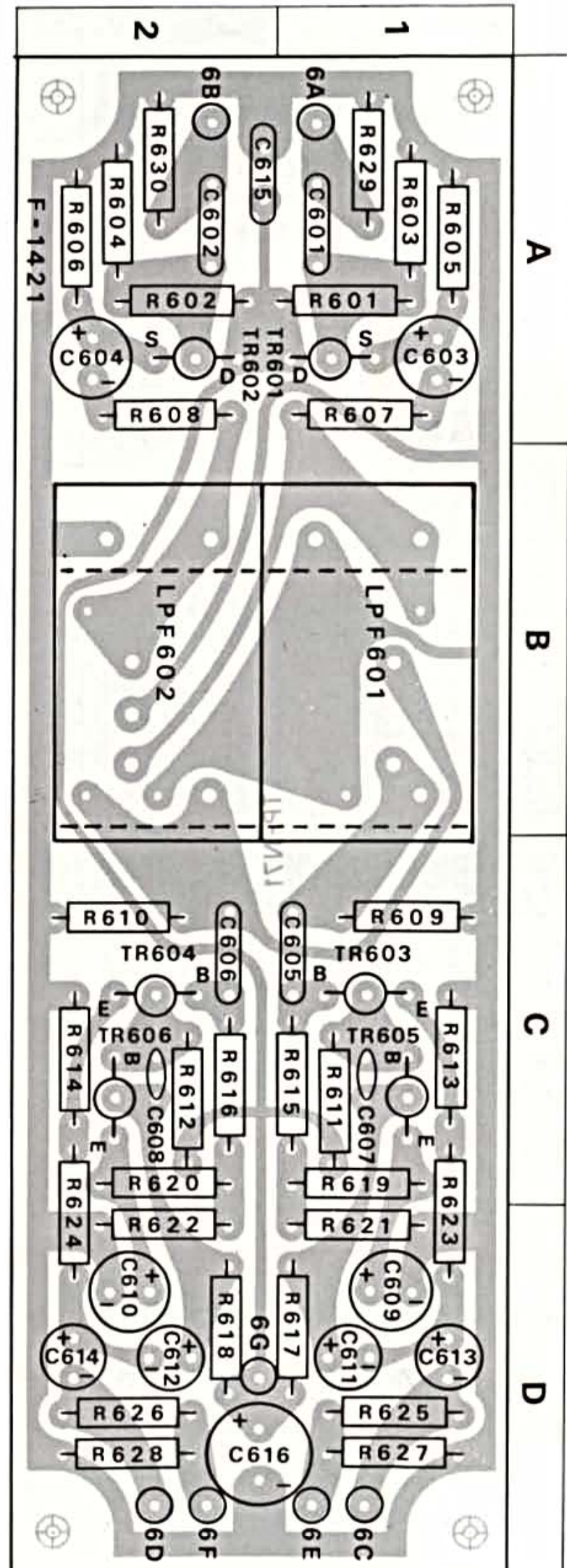

POWER SUPPLY BLOCK <F-1422>

Stock No. 7500680

W	X			Y	Z
R001	22Ω	±10%	1/2W CR.	0103220	1 A, B
R002	4.7kΩ	±5%	1/4W CR.	0107472	1 A, B
R003	10Ω	±10%	1/2W CR.	0103100	1 A
R004	39kΩ	±5%	1/4W CR.	0107393	1 A
R005	18kΩ			0107183	1 A
R006	150Ω	±10%	2W CR.	0105151	2 A, B
R007	10kΩ	±5%	1/4W CR.	0107103	2 A
R008	1.8kΩ	±10%	1/2W CR.	0103182	1 A, B
R009	22Ω			0103220	2 A, B
R010	10kΩ	±5%	1/4W CR.	0107103	2 A
R011	12kΩ			0107123	2 A
C001	0.0022μF	+80% -20%	500V CC.	0659009	2 B
C002	0.0022μF			0659009	2 B
C003	0.0022μF			0659009	2 B
C004	0.0022μF			0659009	2 B
C005	100μF	±10%	25V EC.	0513101	1 A
C006	0.01μF	±10%	50V MC.	0601107	1 A
C007	100μF		25V EC.	0513101	1 A

W	X			Y	Z
C008	0.01μF	±10%	50V EC.	0601107	2 A
C009	100μF		16V EC.	0512101	2 A
C010	0.022μF	±10%	50V MC.	0601227	2 A
C011	100μF		16V EC.	0512101	1 A
C012	470μF		10V EC.	0511471	1 B
C013	1000μF		50V EC.	0549106	1, 2 B
TR001	2SD330 (E)			0308362	1 A
TR002	2SC536 (E)			0305154	1 A
TR003	2SD313 (E)			0308392	2 A, B
TR004	2SC536 (E)			0305154	2 A
TR005				0305154	2 A
D001	10DC-1			0310680	2 B
D002	F-14A			0310940	1 B
ZD001	ZB1-6			0315570	2 A
F-1422 Printed Circuit Board				2500560	

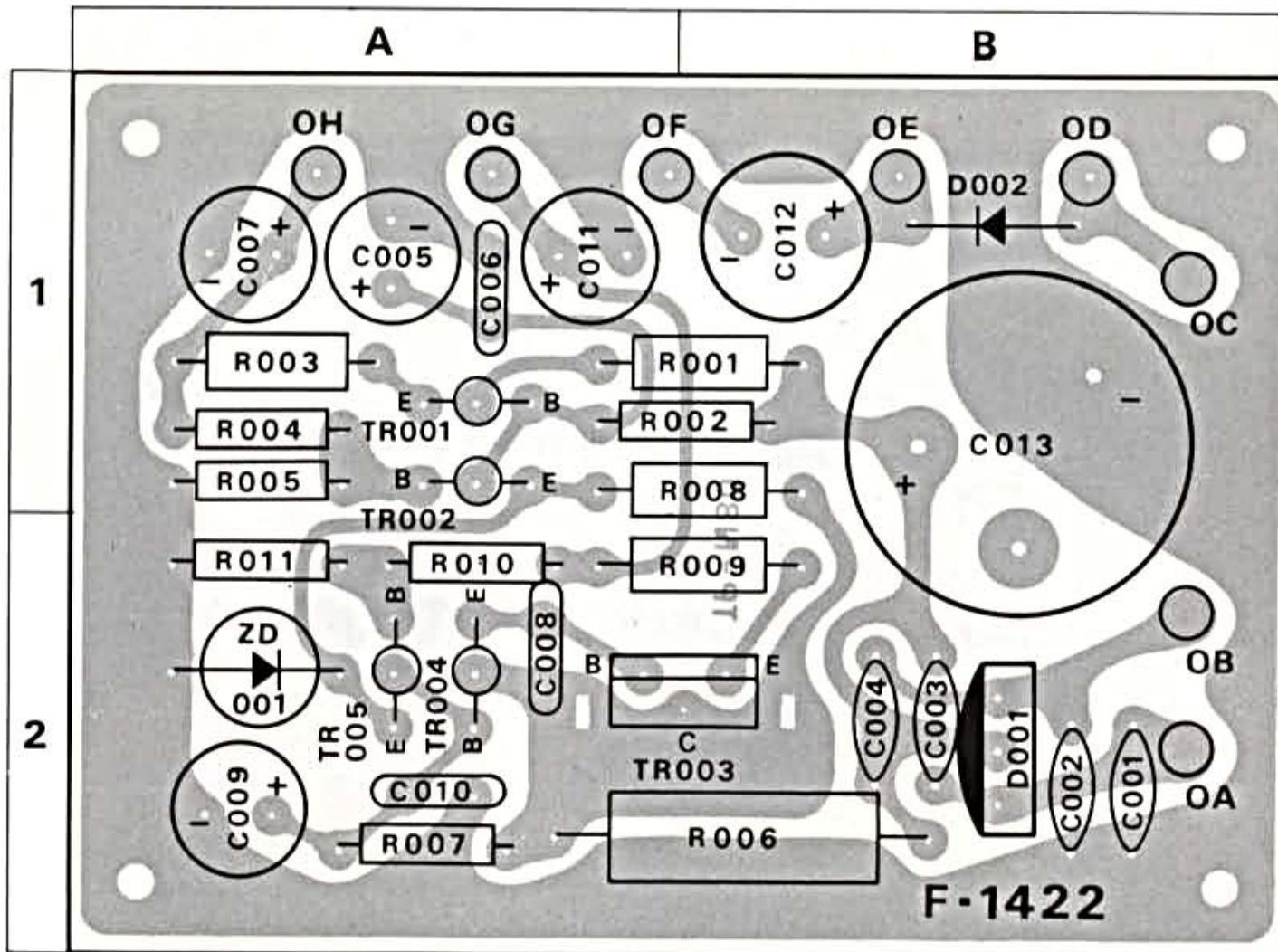

OTHER PARTS AND THEIR LOCATION ON CHASSIS

W: Parts No. X: Parts Name Y: Stock No.

OTHER PARTS

W	X	Y
R021	1.2kΩ	0107122
R022	27kΩ	0107473
R023	4.7kΩ	0107472
R027	68Ω	0107680
R028	680Ω	0107681
R029	4.7kΩ	0107472
R030	1.2kΩ	0107122
R031	220Ω	0107221
R032	6.8Ω ±10% ½W SR.	0111689
VR001	20kΩ (B) × 2 Output Level	1010810
VR002	100kΩ (B) FM Muting Level	1005041
C021	0.0022μF ±10% 50V MC.	0601226
C022	0.0047μF +80% -20% 150V CC.	0659802
C023	0.01μF +80% -20% 900V CC.	0659801

W	X	Y
PT001	Power Transformer	4000650
T001	300Ω : 75Ω Baloon	4290021
T002	AM Bar Antenna	4200550
M001	200μA Signal Meter	4300540
M002	±100μA Tuning Meter	4300550
S1(a-h)	Selector Switch Y-2-7-3	1102200
S2	Power Switch	1170310
S3	FM Muting Switch	1170270
S4	Noise Suppressor Switch	1170270
S5	FM LOC-DIST Switch	1110040
CO001	AC Outlet	2450040

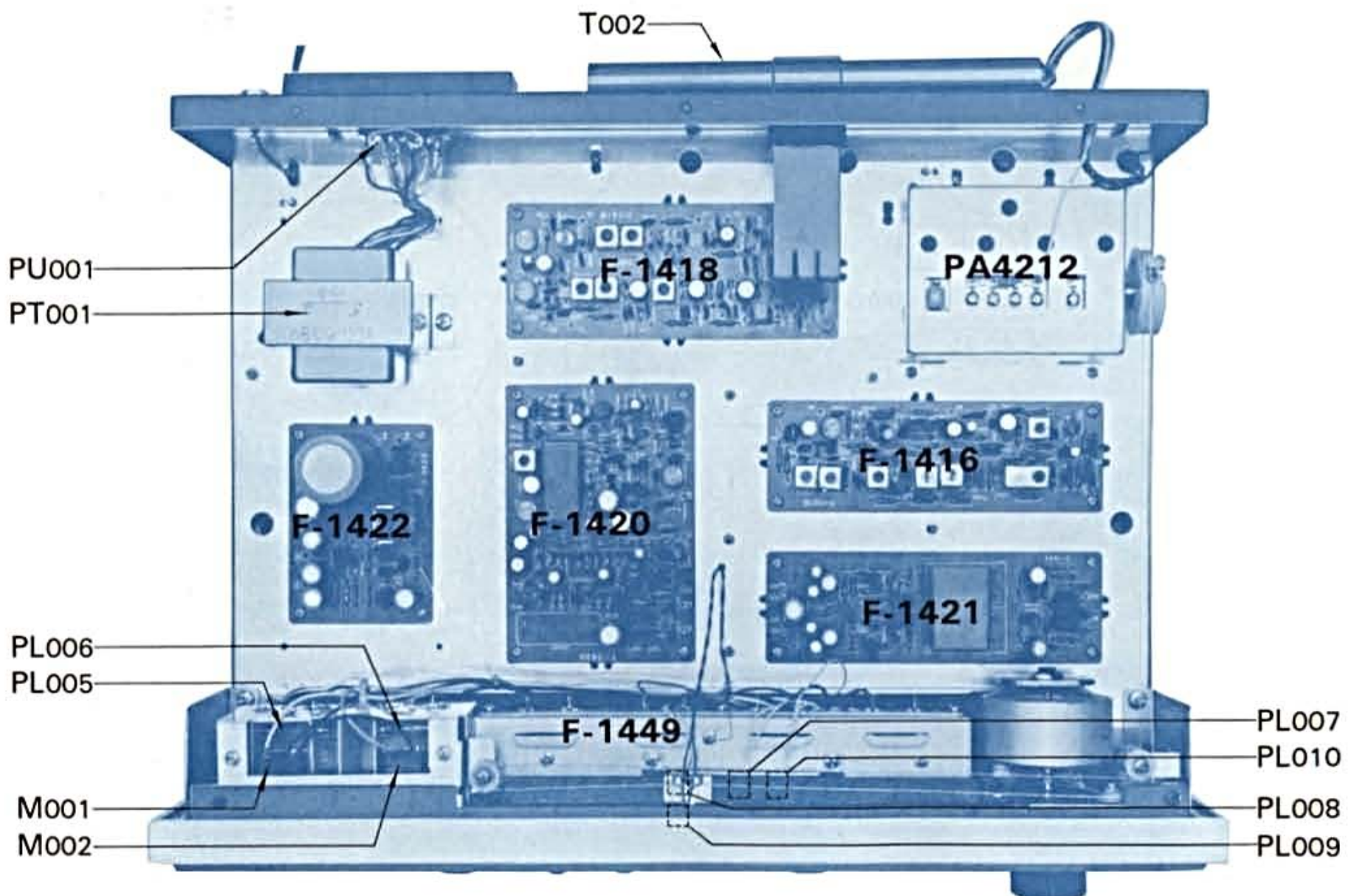

* Design and specifications subject to change without notice for improvements.

W	X	Y
F001	1A Power Fuse (100/117V) 0.5A Power Fuse (220/240V) Fuse Holder	0431222 0431212 2300070
F01	3A Wired in Fuse	0432870
F02	0.5A Wired in Fuse	0432810
F03	0.5A Wired in Fuse F-2026 Printed Circuit Board	0432810 2591370
PL005	6.3V 0.25A Signal Meter Lamp	0420020
PL006	6.3V 0.25A Tuning Meter Lamp	0420020
PL007	7V 0.16A FM Indicator	0400170
PL008	7V 0.16A AM Indicator	0400170
PL009	6V 75mA Dial Pointer Lamp	0400200
PL010	6V 0.1A Stereo Indicator	0400161
	Lamp Socket (× 2)	2310080
	Power Cord	3800020
	Lug Board (× 2)	2110100

W	X	Y
PU001	Voltage Selector Socket Voltage Selector Plug	2410080 2410090
	PA4212U08 FM Frontend	7510560
	F-1418 FM IF Unit	7520540
	F-1420C FM MPX Unit	7540690
	F-1416 AM Unit	7530240
	F-1421A Filter Unit	7591200
	F-1422 Power Supply Unit	7500680
	F-1451 Terminal Unit	7591220
	F-1449 Lamp Holder Unit	7591210

